

SMARTOUCH DIGITAL

USER MANUAL



701 W. Foothill Blvd Azusa CA 91702
(626) 969 - 9655 Fax (626) 334 - 4809

SmarTouch Digital controls are microprocessor based electronic spa control systems and as such are susceptible to static discharge and high levels of humidity. To prevent premature control failure do not hose down, flood or allow water to enter the control box enclosure.

CAUTION

High voltage levels exist inside the control box, they can cause injury and even electrocution.

Only certified electricians or trained servicemen should have access to the components inside the box.

There are no user serviceable parts inside the box. All programming is done at the spa side control panel without the need to access the inside of the box. If for some reason the control system needs to be serviced, please contact Applied Computer Controls for proper procedures.

Model # _____ Serial # _____

Software Rev # _____ Purch Date _____ / _____ / _____

Device	120V	240V	1Sp	2Sp	12V	Installed
Primary Pump	<input type="checkbox"/>	<input type="checkbox"/>	<input type="checkbox"/>	<input type="checkbox"/>		<input type="checkbox"/>
Circulating Pump	<input type="checkbox"/>	<input type="checkbox"/>	<input type="checkbox"/>	<input type="checkbox"/>		<input type="checkbox"/>
Second Pump	<input type="checkbox"/>	<input type="checkbox"/>	<input type="checkbox"/>	<input type="checkbox"/>		<input type="checkbox"/>
Third Pump	<input type="checkbox"/>	<input type="checkbox"/>	<input type="checkbox"/>			<input type="checkbox"/>
Air Blower	<input type="checkbox"/>	<input type="checkbox"/>	<input type="checkbox"/>			<input type="checkbox"/>
Spa Light	<input type="checkbox"/>	<input type="checkbox"/>			<input type="checkbox"/>	<input type="checkbox"/>
Fiber Optic Light	<input type="checkbox"/>	<input type="checkbox"/>			<input type="checkbox"/>	<input type="checkbox"/>
Fiber Optic Wheel	<input type="checkbox"/>	<input type="checkbox"/>			<input type="checkbox"/>	<input type="checkbox"/>
Spa Mister	<input type="checkbox"/>	<input type="checkbox"/>			<input type="checkbox"/>	<input type="checkbox"/>

TABLE OF CONTENTS

INTRODUCTION	4
IN A HURRY	5
Setting Temperature	5
The SET Key	5
Time Of Day TOD	6
SettingTOD	6
THE CONTROL PANEL	7
DEVICE CONTROL GROUP	7
Primary Water Pump	7
Air Blower	8
Auxiliary Pump(s)	8
Spa Light	8
Summary of Device Functions	9
STATUS CONTROL GROUP	10
The TEMP key	10
The TIME key	11
The SET key	11
ERROR MESSAGES	12
CoLD, OH, Hler	13
SEoP, SESH, PSoC, PSoL, PSoH	13
ToE - Time out error	13
ELECTRICAL CONNECTION INSTRUCTION	14
BRANCH CIRCUIT BREAKER REQUIREMENTS	15
EXPLODED VIEW / PARTS	16
PRINTED CIRCUIT BOARD	17
WIRING DIAGRAM	18
CONTROL BOX DESCRIPTION	19
ePACK WIRING DIAGRAM	20

INTRODUCTION

Thank you for buying a spa equipped with a SmarTouch Digital control systems. Many years of experience went into the design of this family of controls. You can be assured your spa control system is the most advanced, it is highly reliable and will serve you for many years to come.

The control system has been designed with the you the user in mind. It is very easy to operate and requires a minimal effort on your part. You may use it just as it comes to you and without any programming. Yet you have the option of getting deeply involved in the inner workings of the control if you so choose. You can custom tailor it to fit your needs.

Please take the time to read at least the first section (next page) "IN A HURRY - READ THIS" portion of the manual before starting to use your spa for the first time. You can familiarize yourself with the rest of the manual at your leisure. This manual will also serve as a reference if you choose to modify the operation of your spa.

SAVE THIS MANUAL.

Make it available for other spa users.

You should also have a spa user's manual which explains how to care for your spa. Please read and follow all instructions in your spa user's manual. Maintaining the proper levels of pH and the sanitizer will extend the life of your spa equipment. Improper chemical levels in the spa are sure to cause premature heater failure as well as failure of other components in the system. Failures caused by chemical imbalance are not covered by warranty.



IN A HURRY - READ THIS

For those who don't like to read manuals or would like to read the manual later, please read at least the following section.

SmarTouch Digital comes to you with a universal set of default settings. If you choose to keep these settings, then you only need to remember 2 things : how to set the spa temperature and to press the SET key whenever you are done using the spa.

Setting Temperature

- ◆ Press and hold the TEMP key for 2 seconds. Release all keys
The display will flash the current selected temperature.
- ◆ Using the TEMP and TIME keys (UP and DOWN arrows) scroll to the desired temperature.
- ◆ Press the SET key to lock in the new selection

The SET Key

After using the spa, press the SET key to tell the microcontroller you are done using the spa. It will then take over the spa's management including the different filtration cycles, heat maintenance, economy modes and protection against freezing.

Upon entering this mode the FILTER light is turned on and a post use filtration cycle is executed - that is when the spa needs filtration the most. The default system setting includes a 3 hour economy mode, the pump will come on at most once every 3 hours to sample water temperature and heat if necessary. The controller remembers when you have used the spa and in anticipation of your next usage will perform a 3 hour Auto Filtration cycle before your next spa use.

SmarTouch Digital Series 1000 and 2000 is a family of intelligent, spa control systems. These systems are rich with features and can be extensively programmed to fit just about any need. The rest of this manual will explain the function of each of the keys on the control panel, how to change programmed settings and what each setting does. It will also explain all the error messages that you may encounter, and their significance and way to correct them.

Time Of Day (TOD)

SmarTouch Digital maintains a 12 hour AM / PM internal real time clock TOD (Time Of Day). The clock based on the line frequency. There is no battery backup and whenever the power is turned off, TOD is no longer correct. It defaults to 12:00 AM whenever the power is turned on.

If you set TOD then SmarTouch will display time every first 10 seconds of each minute. If TOD has not been set then it will not be displayed.

Setting TOD (Optional)

1. Press and hold the TIME key for 2 seconds. Current TOD will be displayed with the hour portion flashing.
2. Release the TIME key.
3. Using the TEMP and TIME keys scroll up and down to the desired hour. - Notice the AM / PM Led.
4. When the correct hour and AM / PM are displayed press the SET key to lock in the new hour.
5. The display will now flash the minutes portion of current TOD.
6. Using TIME and TEMP scroll to the desired minutes.
7. When the correct minutes are displayed press the SET key to lock in the time of day (hours and minutes)

Note : TOD is the only parameter in SmarTouch Digital that is not preserved on power down. On power up it will default to 12:00 AM, all other parameters are restored to the their last setting.

THE CONTROL PANEL

The control panel is normally installed on the lip of the spa for easy and convenient access. Within the panel housing is a 4 digit LED display used to communicate to the user spa temperature, TOD, elapsed user time, programming, status - diagnostic and error codes and messages. There are 2 different size panels. They are interchangeable. the 2000 Series panel can have up to 7 keys, the 1000 Series panel will have at most 6 keys. These are membrane type switches which when depressed generate a signal that the microprocessor will interpret and act upon. The switches are labeled and have specific functions. They are divided into 2 groups:

Device Control Group Pump(s), Air Blower & Spa Light.
Status Control Group: Up & Down Keys & the Set Key.

Note: if any of the keys is pressed and held closed for longer than 20 seconds, that key will be disabled and becomes non functional. After releasing the key, it will be reactivated after 20 seconds. This is to prevent a collapsed or defective key from locking up the system.

DEVICE CONTROL KEYS

There are up to 4 device key, JETS, AIR, AUX & LITE. Your spa will have at least one water pump. Optionally your spa may have an air blower, a second and/or third pump and a spa light. It may also have a mister or a fiber optic light setup. If your spa does not have a specific device please disregard the function of that device.

Primary Water Pump

Each spa should have at least one primary water pump which is usually a dual speed pump. The low speed is used to filter the spa. Also while the spa is being heated or there is an error condition, the low speed circulates the water and you will not be able to turn it off.

The **JETS** key (switch) on the control panel is a 3 position switch : Low Pump, High Pump, Off. Each time the key is pressed, the next function is executed. If your primary pump is a single speed pump then only the high pump will be activated. 2 LED indicators, LO & HI inform you which speed is on.

Note : if your spa is equipped with a circulating pump it will be used for filtration and heating instead of the low speed pump.

Air Blower.

If your spa is equipped with an air blower (bubbler), it is activated by the **AIR** key. This is an ON/OFF key. An LED will indicate when the air blower is on.

Auxiliary Pump(s).

Your spa may be equipped with 1 or 2 more pumps. If you have a second pump, it could be a single speed or a dual speed.

If you have a third pump then both the second and third pumps must be single speed. The function of the **AUX** key changes with the number and type of auxiliary pumps used. Please consult with the table on the following page for the proper sequence of activation.

Spa Light

The **LITE** key can also be a multifunction key. In its simplest configuration, the **LITE** key is a simple on / off switch. It turns the spa light and the accessory, if one is attached, on / off together at the same time. Alternatively the LITE key may be programmed as a 3 function key. Pressing it once will turn the spa light on. Pressing it a second time will turn on the attached accessory, while the light is still on. Press it a third time and both spa light and accessory will go off.

The table on the following page summarizes all the possible device key combinations. Please note that your spa may not necessarily have all these devices attached.

SUMMARY OF FUNCTIONS FOR EACH DEVICE

Key	Device	1	2	3	4
	Single speed pump	ON	OFF		
JETS	Dual speed pump	LOW	HIGH	OFF	
	Dual speed with Circ pump Circ pump is independent	LOW	HIGH	OFF	
AIR	Single speed air blower	ON	OFF		
	One single Speed pump	ON	OFF		
AUX	One dual speed pump	LOW	HIGH	OFF	
	Two Single speed pumps	P1	P1&2	P2	ALL OFF
	Spa light	ON	OFF		
LITE	Spa Light & Accessory	Both ON	Both OFF		
	Spa Light & Accessory 3 Function	Lite ON	Both ON	Both OFF	

Table 1 - Device keys summary of functions

The four device keys, JETS, AIR, AUX and LITE are exclusive, when one is pressed, no other key may be pressed simultaneously. You must release the pressed key before you may press another key. Also these keys do not repeat.

If you press and hold a key for more than 20 seconds that key will be considered defective (collapsed) and will be deactivated and ignored by the system. When released the key will stay inactive for 20 seconds before it is recognized and activated.



STATUS CONTROL KEYS

The keys in this group are used to communicate to the controller system settings and option selection(s). There are 3 keys in this group and 3 functions that are combinations of these keys:

Key Press	Function
TEMP (up arrow) TIME (down arrow) SET key.	Prog Temp, + or Next Prog TOD, - or Previous Select or Accept , Enter
SET & TEMP	Invert display

Table 2 - Status Control Keys Summary

The **TEMP** key , which is also the UP ARROW key, is a repeat key if held down. Think of this key as “+ or next”. Use it to :

- ◆ Press and hold for 2 seconds then release it to start desired temperature selection.
- ◆ During temperature setting press TEMP to increase selected temperature.
- ◆ When doing system programming press TEMP to scroll to the next message.
- ◆ After message selection, the system displays the associated value, press TEMP to increase that value.

Note: When the display is inverted, you will be able to read the display from inside the spa ; the keys will retain their functions and will not be inverted. The UP ARROW will still function as the UP ARROW even though when you look at it from within the spa it appears to be the DOWN ARROW. The same also applies to the rest of the keys.

The **TIME** key , which is also the DOWN ARROW key, is also a repeat key. Think of it as “ - or previous”. Use it to :

- ◆ Press and hold for 2 seconds then release it to start setting the real time clock (TOD)
- ◆ During time setting press TIME to decrease the hours or minutes value that is being set.
- ◆ When doing system programming press TIME to scroll to the previous message
- ◆ After selecting a message, the system displays the associated value, press TIME to decrease that value.

The **SET** key is equivalent to Select or Accept. It functions as an Enter key of a personal computer, it is the proverbial “hit any key to continue”. Press the set key to:

- ◆ After using the spa press the SET key to tell the controller to take over the management of the spa.
- ◆ During temperature setting press the SET key to lock in a new selected temperature.
- ◆ During time of day programming press the SET key to lock in the hour and the minutes.
- ◆ When a “**HLer**” error message is displayed press the SET key to clear the error (if the cause has been corrected). Pressing the SET key, the user acknowledges that the cause of the hi limit error has been or will be corrected.

Note: UP is synonymous with TEMP and DOWN is the same key as TIME. These are used interchangeably and mean the same thing. Scrolling means pushing either the UP or the DOWN key to go to the next or previous item or value.

ERROR MESSAGES

There are 9 error messages that a SmarTouch may generate. Here is a List of these messages and what they indicate:

CoLd Temperature in the spa heater housing is below 40° Fahrenheit. Because spa temperature should never get this low, the status of the heater element is unknown. Therefore the low speed pump or circulation pump will run continuously until the temperature rises above 45°

OH OverHeat. The spa is at temperature that is above 108°F. SmarTouch will not accept temperature settings above 104°F. If for some reason spa temperature rises over the maximum level, SmarTouch will display a flashing 105°F to 108°F. The spa is still operational but hotter than any person should be subjected to. Please do not use your spa when the temperature is flashing or the OH message is displayed

In the summer and especially in warm regions, ambient temperature may be high enough to overheat the spa naturally. Spas are usually well insulated and can store a lot of heat in the equipment compartment.

HLer Hi Limit Over Heat. SmarTouch has a backup water temperature sensor called the HiLimit. If the sensor is disconnected or shorted or if the spa temperature should reach above 112°F, the HiLimit protection circuitry will force all spa functions off and will flash the HLer message on the display. It is not possible to use the spa when this error is in effect. When the error has been corrected, you must press the SET key to acknowledge that you, the spa user, are aware of the error condition and should have the proper repairs done.

SEoP Sensor Open or disconnected and SmarTouch cannot determine the spa temperature. The heater is disabled but the spa is operational. The sensor must be replaced or reconnected for this message to go away.

SESH Sensor Short. The sensor is shorted and is non functional. Temperature cannot be determined, the heater is disabled, but the spa is still operational. Sensor must be replaced to get rid of this message.

PSoC, PSoL, PSoH Pressure Switch Open with Circulating, Low or High pump(s). The pressure switch is a device sensitive to pressure inside the heater manifold. Pressure in the heater manifold is generated by a pump pushing water through the manifold. If one pump is running and the pressure switch does not sense any pressure then there is an indication of no water flow. To prevent the heater from being turned on when there is no water running through, the heater is turned off and one of these messages will be displayed indicating which pump is supposed to be running.

A pressure switch error may also be indicated if the switch is out of adjustment or there is an air lock in the pump. Adjusting the pressure switch is best left to a trained technician. An air lock may happen whenever the spa is so low as to permit air to be sucked in by the pump. To bleed an air lock; switch off power, loosen one of the pump fittings a quarter of a turn. You will hear the sound of escaping air, then water will start dripping. Retighten the fitting.

ToE Time Out Error. It is not likely that you will ever see this error. It indicates that the system's heartbeat is out of control, all devices will be shut down and the spa is unusable. This message will rarely ever occur, if it does, please contact Applied Computer Controls.

ELECTRICAL CONNECTION INSTRUCTIONS

NOTICE: All spa electrical wiring must be performed by a qualified licensed electrician and must meet all NEC (National Electrical Code) and state and local codes and requirements.

DANGER - RISK OF ELECTRIC SHOCK

1. The lines carrying power to the spa must be dedicated to the spa and should not be shared with any other appliance(s).
2. All electrical wiring lines must originate from the electrical panel and terminate, hard wired, into the electrical wiring compartment. The use of extension cords or plug type termination is expressly prohibited and voids the warranty.
3. Do not use aluminum wiring. Use only copper wiring.
4. Wire gauge must be in accordance with NEC requirements for the distance from current source to spa and the current rating as stated on the ID label that is attached to the control enclosure.
5. All wiring must be shielded by a ground metal conduit. The conduit must terminate at the electrical access compartment either from the bottom of the spa or through a hole in the side paneling of the spa.
6. For a 120 volt system the line wire (black) is connected to the terminal block lug labeled LINE1. The neutral wire (white) is connected to the center lug labeled NEUT, and the ground wire (green) is connected to the ground lug labeled G or GROUND.
7. For a 240 volt 4 wire system, connected Line1, Neutral and Ground wires as in #6 above. The fourth wire is the Line2 wire (red) and it is connected to the lug labeled LINE2.

BRANCH CIRCUIT BREAKER REQUIREMENTS

240 Volts 4 Wire System **30/50 Amp 2 Pole Breaker**

240 Volt 3 Wire System **30/50 Amp 2 Pole Breaker**

CAUTION : A new breaker must be used for a new spa installation. Do not use an existing or used breaker.

GFCI. All spa installations must be protected by a GFCI. If your spa control box does not include an integrated GFCI then you must use a GFCI breaker per National Electrical Code requirements.

120/240 Volt Conversion. All spas are shipped configured for 240 volt (3 or 4 wire systems). Please check the nameplate on the control enclosure to identify the type of system in your spa. If the nameplate indicates a 120/240 Volt type system, then it is possible to convert the spa to 120 volt operation.

30/50 Amp Conversion. Some homes may have limited power service. It is possible to operate a 240 volt spa system using a 30 amp breaker. Connect 240 volt power to the system as previously described, then set it to operate in the low power mode. To set the controller to operate in low power mode, you must set system option P3 to 1. Please read the note on page 18 and the warning on page 19.

Note: Only experienced service personnel should perform conversions. Improper modifications may cause damage to the control system and / or the attached heater and pump motors.

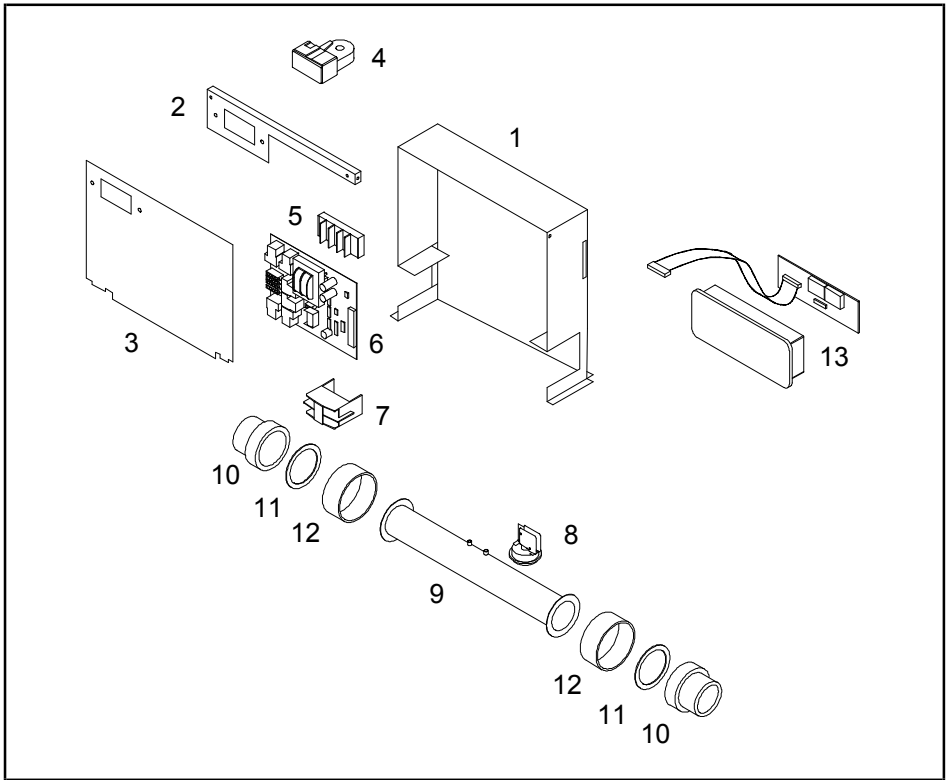

SmartTouch Digital Typical view - exploded

1. Enclosure Box
2. GFCI Flange
3. Cover Plate
4. GFCI (optional) - 120 volt 20 amp or 240 volt 50 amp
5. Terminal Block - 2 position or 3 position
6. Printed circuit control board - SC2000, SC1000, SC1100Jr
7. Heater contactor
8. Pressure Switch
9. Stainless steel heater manifold tube
10. Heater union, mail fitting.
11. Gasket
12. Heater union, female fitting
13. Spa side control assembly

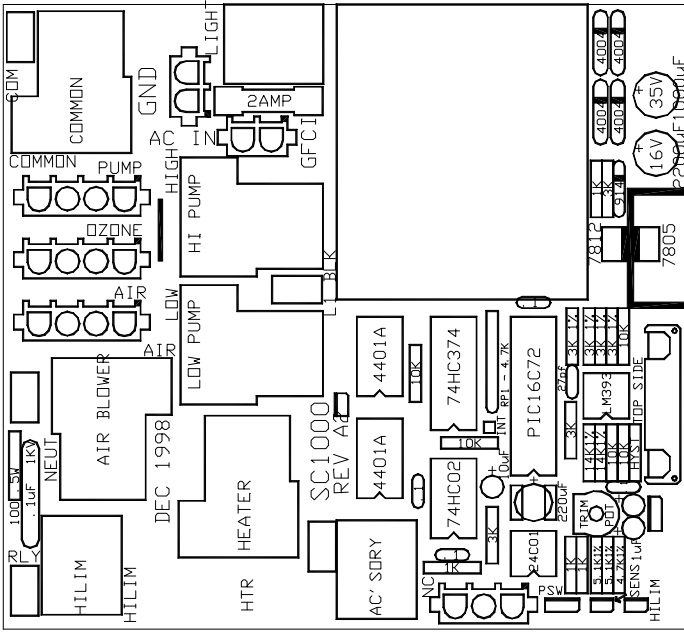

SC-1000 Control Board

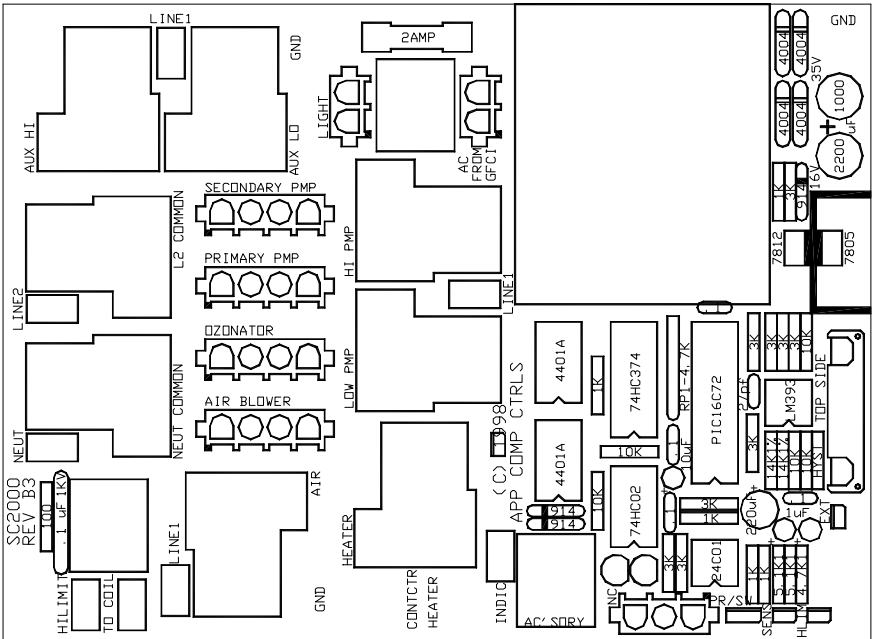

SC-2000 Control Board

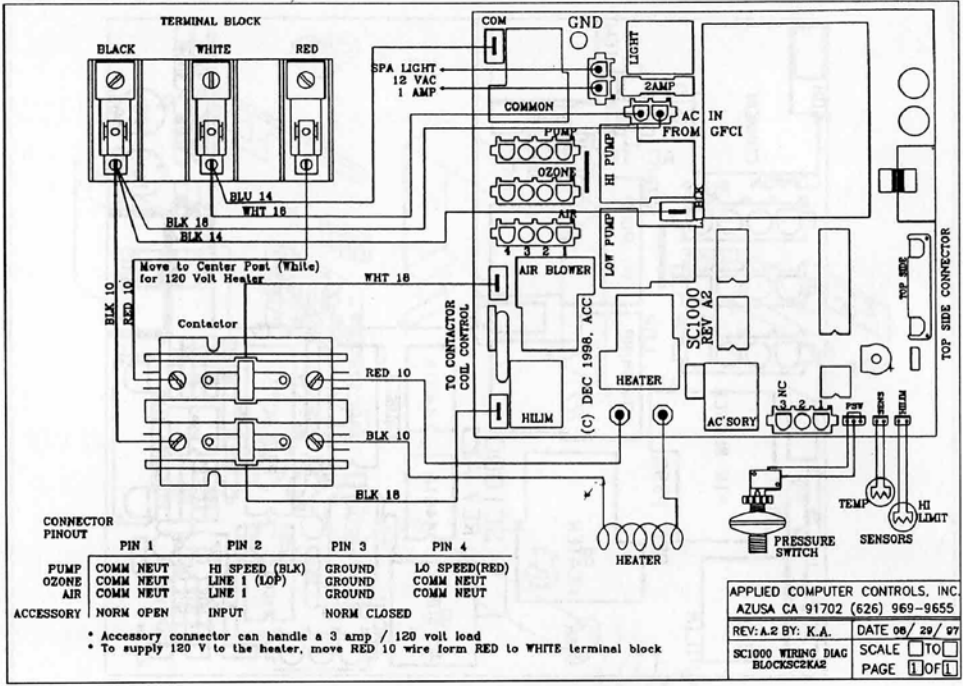

WIRING DIAGRAM FOR SMTD 1000

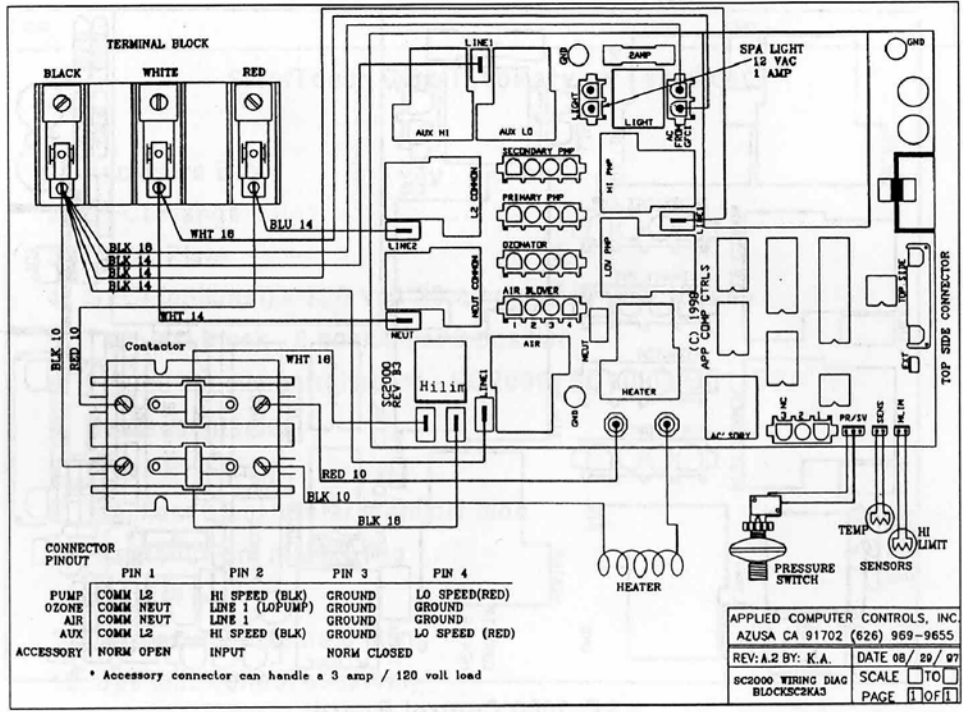

WIRING DIAGRAM FOR SMTD 2000

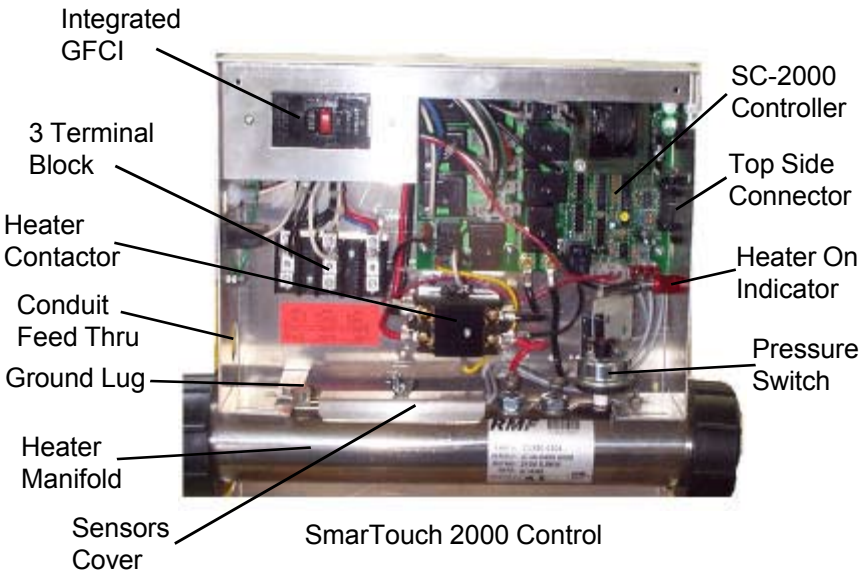
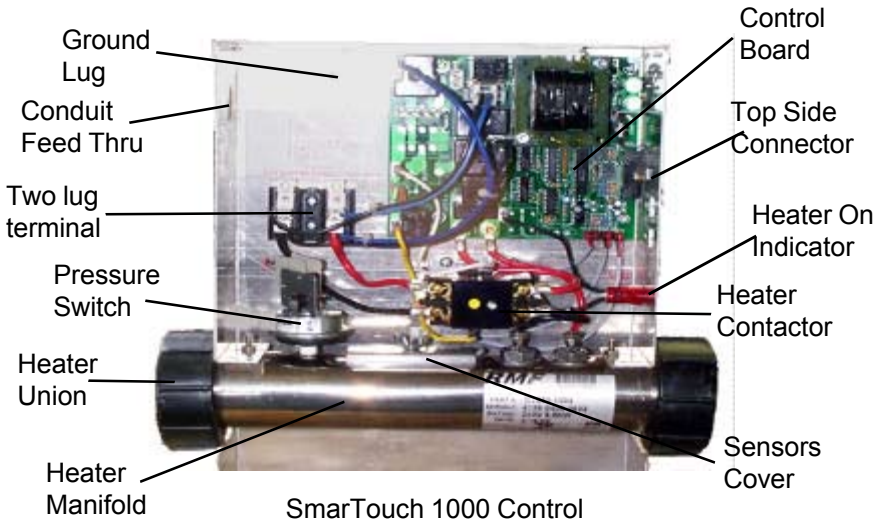

ePACK WIRING DIAGRAM

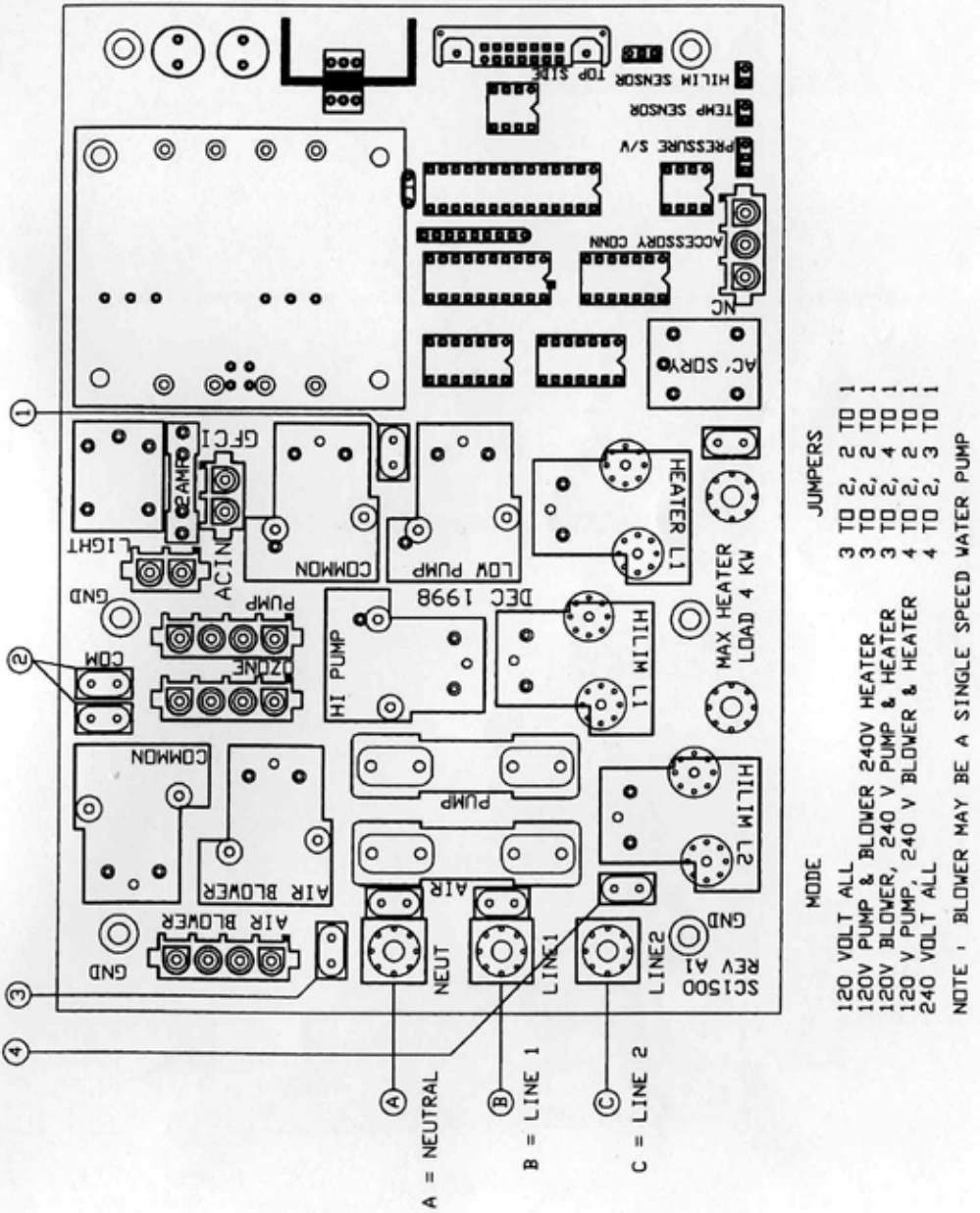

IMPORTANT SAFETY INSTRUCTIONS
READ AND FOLLOW ALL INSTRUCTIONS.

WARNING

- To reduce the risk of injury, do not permit children to use this product unless they are closely supervised at all times.
- A wire connector is provided on this unit to connect a minimum 8 AWG (8.4MM²) solid copper conductor between this unit and any metal equipment , metal enclosures of electrical equipment, metal water pipe, or conduit within 5 feet (1.5m) of the unit.
- **WARNING:** For indoor use only. This unit is not intended for outdoor use.
- **CAUTION: THE EQUIPMENT AND CONTROLS SHALL BE LOCATED NOT LESS THAN 1M (5FT) HORIZONTALLY FROM THE SPA OR HOT TUB**

CANADA

- **Attention:** Maintenir une distance minimale, mesuree dans un plan horizontal., de 1M entre la cuve de relaxation et les appareils et commandes.

Only a licensed electrician can install power to the spa.

Spa power supply installation must include a properly rated GFCI/Circuit Breaker, as per label on control box enclosure.

Supply lines must be properly sized as per National Electric Code.

ELECTRICAL INSTALLATION INSTRUCTIONS.

All electrical wiring must be performed by a qualified, licensed electrician in order to meet NEC, (National Electrical Code) state and local codes.

- This unit is a “Permanently Connected Equipment Assembly with Pump(s), Heater, Blower and Control.”
- The lines carrying power to the spa must be dedicated and should not be shared with other appliances. **Use copper wiring only. Use # 6 AWG conductors.**
- A pressure wire connector is provided on this unit to connect a minimum 8 AWG (8.4mm²) solid copper conductor between this unit and any metal equipment, metal enclosures of electrical equipment, metal pipe , or conduit within 5 feet (1.5m) of the unit
- The electrical supply for this unit must include a suitably rated GFCI/ CIRCUIT BREAKER to open all ungrounded supply conductors to comply with Section 422-20 of the National Electric Code.
- A quick disconnect marked OFF must be readily accessible to the tub occupant , installed at least 5 feet (1m) from the tub.
- All electrical wiring lines must originate from the main electrical panel and terminate, hard wired, into the electrical wiring compartment. The use of extension cords, or plug type termination is expressly prohibited and voids the warranty.
- Minimum supply conductor ampacity must be 125 percent of the current rating stated on the ID label affixed to, equipment control enclosure.

BREAKER CAPACITY 50 AMPS 240V SINGLE PHASE

VOLTS	AMPS	HZ	PHASE
240	41	60	1
PERMANENTLY CONNECTED			
USE #6 AWG COPPER CONDUCTOR			

3-WIRE 220V CONNECTIONS + GROUND

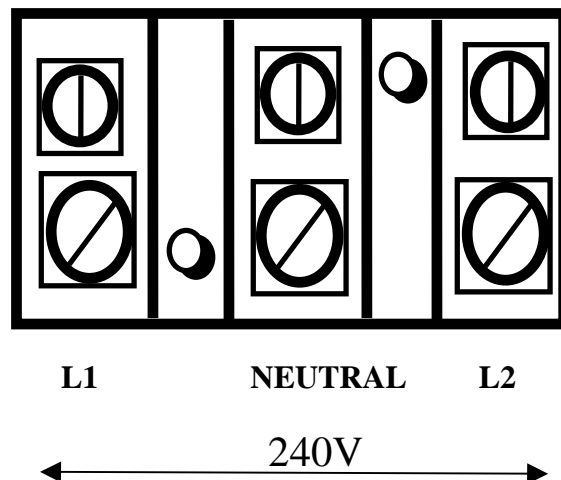

© 1999 Applied Computer Controls.
SmarTouch & SmarTouch Digital are trademarks of Applied Computer Controls.
This manual may not be copied or reproduced without permission, in part or in total.